

Typ Model

# MN-4500 series

Vícejehlové ramenové stroje

Multi needle machines

# GARUDAN®

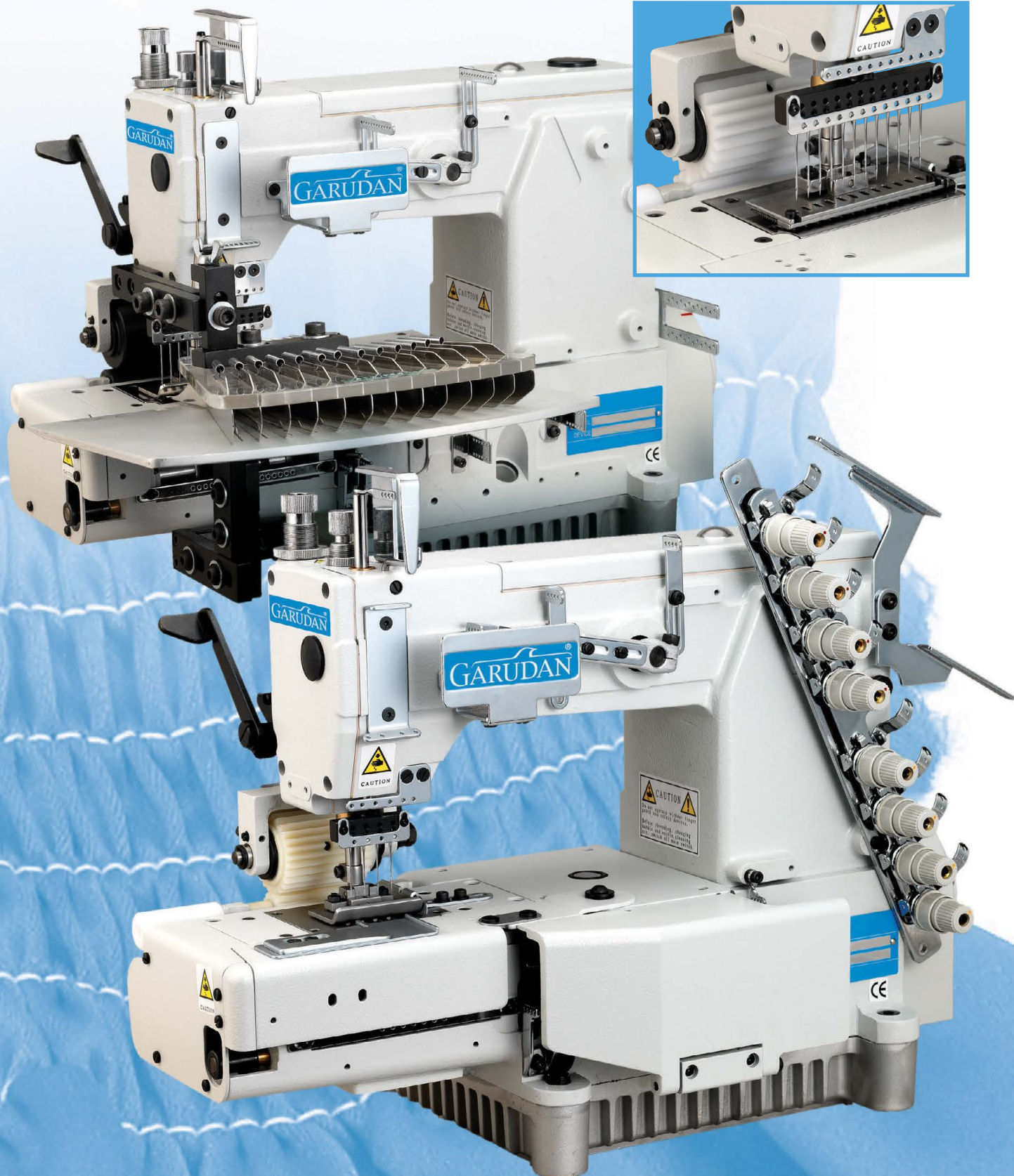
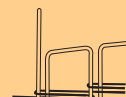

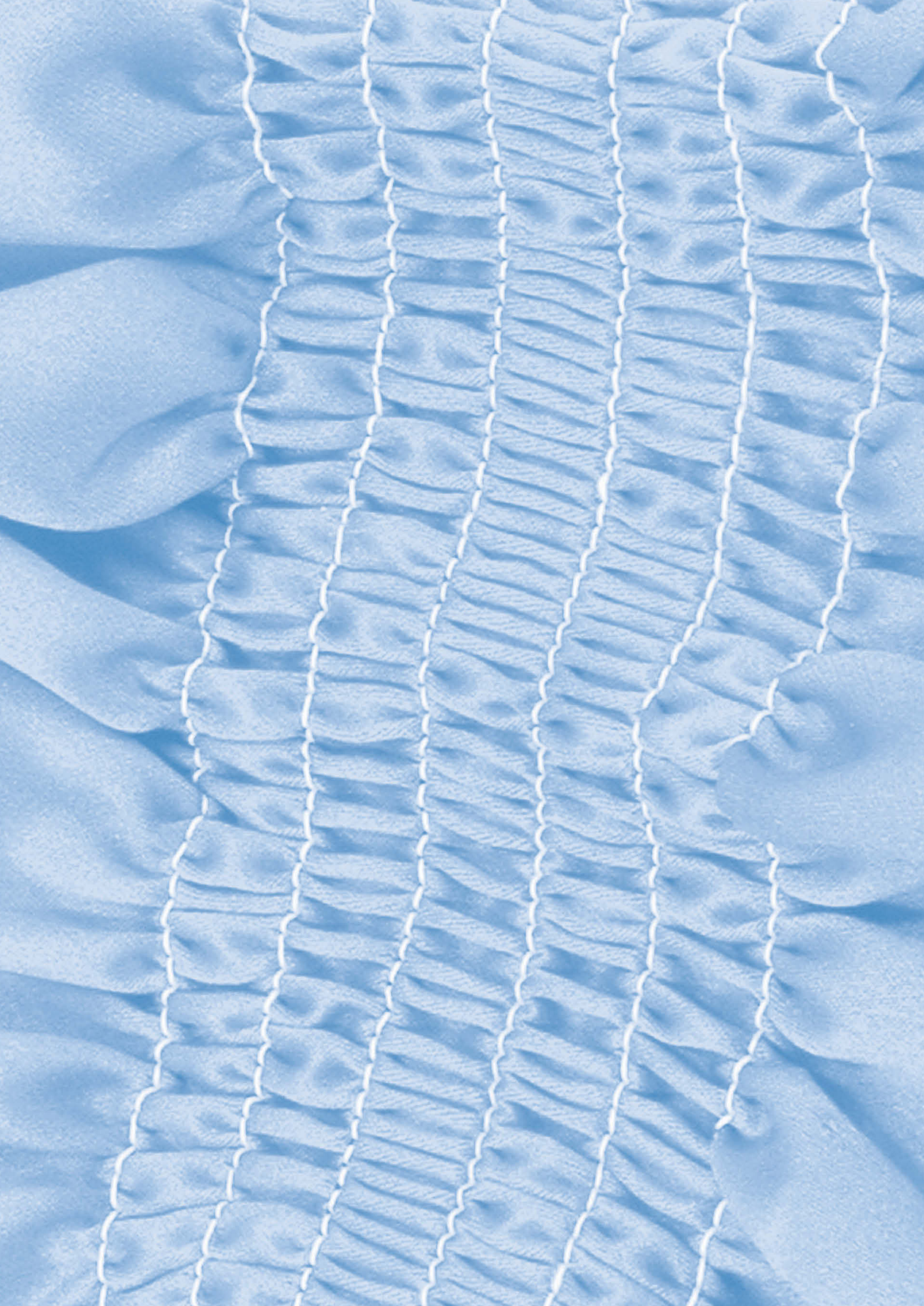

**MODELOVÉ ZNAČENÍ**

**MODEL NUMBERING**

MN-4504P □ - 064 □ / PMD

1 2 3 4 5 6 7

**1 TYPOVÁ ŘADA:**

MN: vícejehlové ramenové stroje

**2 POČET JEHEL:**

04: čtyřjehlové  
06: šestijehlové  
09: devítijehlové  
12: dvanáctijehlové  
13: třináctijehlové

**3 ODTAHOVÝ VÁLEC**

**4 TYP ODTAHOVÉHO VÁLCE:**

S: standardně je dodáván odtahový válec, horní 28 zubů, spodní 15 zubů  
0: odtahový válec horní hladký, spodní hladký  
1: odtahový válec horní 18 zubů, spodní 10 zubů  
2: odtahový válec horní 22 zubů, spodní 12 zubů  
3: odtahový válec horní ocelový – zubatý, spodní hladký



P STANDARD



P 0



P 1



P 2



P 3

**5 ROZTEČ JEHEL:**

032: 3,2 mm  
048: 4,8 mm  
050: 5,0 mm  
064: 6,4 mm  
085: 8,5 mm  
095: 9,5 mm  
106: 10,6 mm  
127: 12,7 mm

**6 PODTŘÍDA:**

A: kompenzační dělená patka (pouze u čtyřjehlových strojů když B = C = D)

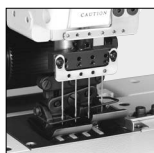

**7 VOLITELNÉ PŘÍSLUŠENSTVÍ:**

PMD: mechanické dávkování  
FR401: zakladač pro šití gemy  
:  
(Detaily naleznete na dalších stránkách)

**1 MODEL:**

MN: Multi needle machines

**2 NUMBER OF NEEDLES:**

04: 4-Needle  
06: 6-Needle  
09: 9-Needle  
12: 12-Needle  
13: 13-Needle

**3 REAR PULLER**

**4 TYPE OF PULLER:**

S: Standard type: Upper roller 28 teeth, lower roller 15 teeth  
0: Upper roller 0 teeth, lower roller 0 teeth  
1: Upper roller 18 teeth, lower roller 10 teeth  
2: Upper roller 22 teeth, lower roller 12 teeth  
3: Upper steel roller with teeth, lower roller 0 teeth



P STANDARD



P 0



P 1



P 2



P 3

**5 NEEDLE DISTANCE:**

032: 3,2 mm  
048: 4,8 mm  
050: 5,0 mm  
064: 6,4 mm  
085: 8,5 mm  
095: 9,5 mm  
106: 10,6 mm  
127: 12,7 mm

**6 SUB-CLASS:**

A: Bisector presser foot (for 4-needle machines only if B = C = D)

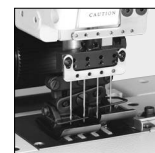

**7 OPTIONAL DEVICE:**

PMD: Lower feed metering device  
FR401: Elastic hemming 2-folds  
:  
(Details at following pages)

## CHARAKTERISTIKA

## GENERAL FEATURES

- Maximální rychlost šití do 4500 stehů za minutu.
- Automatické tlakové mazání zaručuje dlouhou životnost stroje a dílců (obr. A a B).
- Patentovaný systém nitové páky redukuje přenos vibrací a možnost znečištění olejem.
- Jednoduché nastavení délky stehu (obr. C).
- Obvod ramene je 43 cm (včetně spodního odtahového válce, obr. D).
- Možnost měnit jednoduše rozpichy pomocí šicích sad.
- Široký rozsah přídatných aparátů.

- Maximum sewing speed up to 4500 stitches per minute.
- Automatic oiling system provides longer machine's and parts' life (pic. A and B).
- Patented thread take-up lever system reduces sewing vibration and prevents from oil leaking.
- Easy operated adjustment of stitch length (pic. C).
- Cylinder bed circumference is 43 cm (including the lower roller of rear puller, pic D).
- Different sewing requirements can be achieved by changing gauge sets.
- Large selection of various attachments.

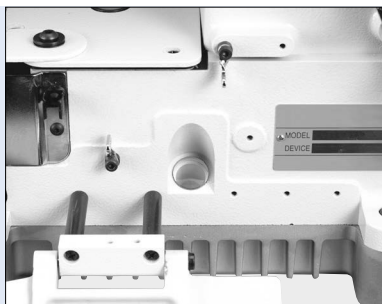

obr. A



obr. B

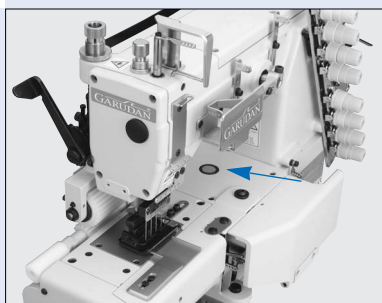

obr. C



obr. D

## MN-4504P

ČTYŘJEHLVÉ OSMINITNÉ STROJE

4-NEEDLE, 8-THREAD MACHINE



MN-4504P

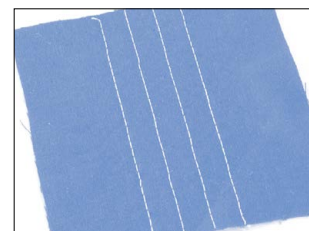

### CHARAKTERISTIKA:

Tato řada strojů je standardně dodávána s odtahovým a napínacími válci a vodítkem, které je vhodné zejména pro šteповání gummy v pasovém límcu. Velké množství rozpichů umožňuje stroj použít i pro mnoho jiných šicíh operací.

### POUŽITÍ:

- Spodní prádlo, košile, kalhoty, pracovní oblečení, povlečení, závěsy, záclony atd.

### VOLITELNÉ PŘÍSLUŠENSTVÍ:

- PMD – mechanické dávkování
- FR406 – vybavení pro našívání pásek

### GENERAL FEATURES:







This series is supplied with rear puller, fabric tension controlling device and guide that is suitable for waistband elastic tape attaching. Large selection of various gauge sets enables many other sewing operations.

### APPLICATION:

- Suitable for attaching elastic tape to the waist of trunks, boxers and similar garments.

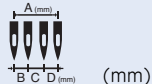
### OPTIONAL DEVICE:

- PMD – Lower feed metering device
- FR406 – Line stripes attaching device

								AVAILABLE DEVICE
MN-4504P-064(A)			A B C D					
MN-4504P-085(A)			19,2 6,4 6,4 6,4					
MN-4504P-095(A)			25,5 8,5 8,5 8,5					
MN-4504P-106(A)			28,5 9,5 9,5 9,5					
MN-4504P-127(A)	4	8	31,8 10,6 10,6 10,6					
MN-4504P-127(A)			38,1 12,7 12,7 12,7	1,6-3,6	8	75-90	4500	PMD FR406
MN-4504P-048-191			28,7 4,8 19,1 4,8					
MN-4504P-048-254			35,0 4,8 25,4 4,8					
MN-4504P-064-127			25,5 6,4 12,7 6,4					
MN-4504P-064-191			31,9 6,4 19,1 6,4					
MN-4504P-064-254			38,2 6,4 25,4 6,4					

## MN-4506P

ŠESTIJEHLOVÉ DVANÁCTINITNÉ STROJE

6-NEEDLE, 12-THREAD MACHINE

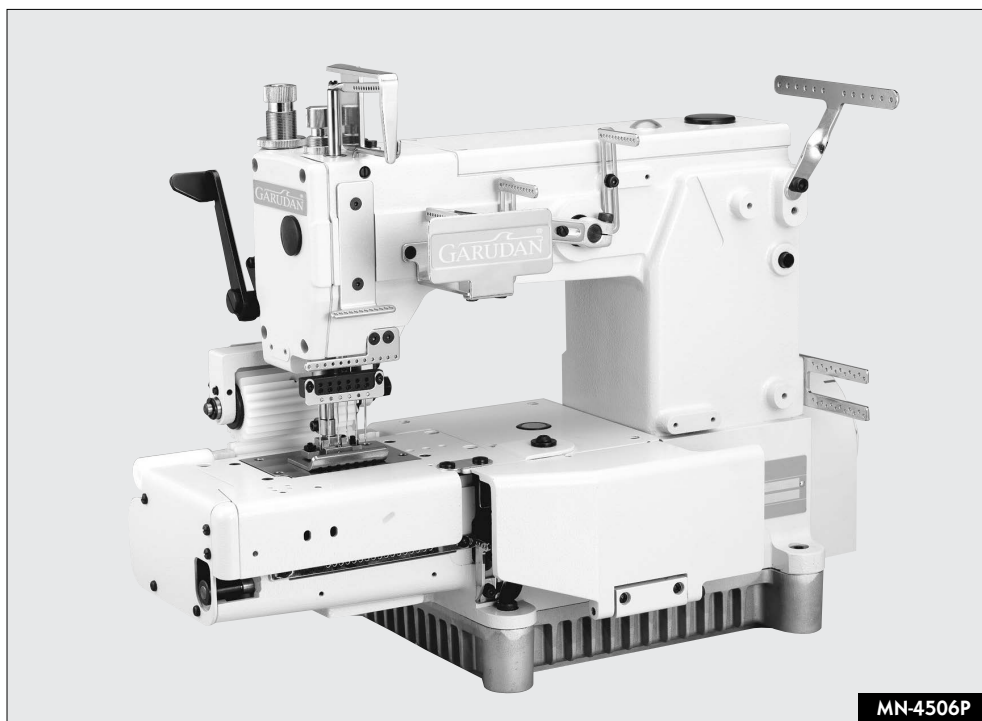

MN-4506P

### CHARAKTERISTIKA:

Tato řada strojů je standardně dodávána s odtahovým válcem. Stroj lze objednat s rozpíchem jehel 6,4 mm, 8,5 mm a 9,5 mm. Doporučeným vybavením je FR406, které umožňuje našít až 3 pásy. Použitím jiných vybavení lze stroj použít i na další šicí operace.

### POUŽITÍ:

- Kalhoty, pracovní oblečení, bundy atd.

### VOLITELNÉ PŘÍSLUŠENSTVÍ:

- PMD – mechanické dávkování
- FR406 – vybavení pro našívání pásek

### GENERAL FEATURES:







This series is supplied with rear puller and can be ordered with 6,4 mm, 8,5 mm or 9,5 mm gauge sets. Suggested device is FR406 that enables to attach up to 3 tapes. Machine can be used for other sewing operations by using other devices.

### APPLICATION:

- Suitable for attaching elastic tape to the waist of trunks, boxers and similar garments.

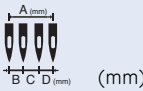
### OPTIONAL DEVICE:

- PMD – Lower feed metering device
- FR406 – Line stripes attaching device

			 (mm)	 (mm)	 (mm)	 UO x 113	 S.P.M.	AVAILABLE DEVICE
MN-4506P-064			A      B 32,0    6,4					
MN-4506P-085	6	12	42,5    8,5	1,6–3,6	8	75–90	4500	PMD FR406
MN-4506P-095			47,5    9,5					

## MN-4509P

DEVÍTIJEHLOVÉ OSMNÁCTINITNÉ STROJE

9-NEEDLE, 18-THREAD MACHINE



MN-4509P

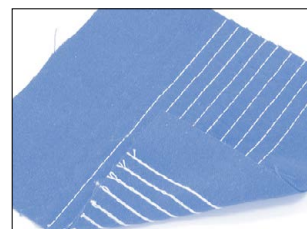

### CHARAKTERISTIKA:

Tato řada strojů je standardně dodávána s odtahovým válcem. Stroj se standardně dodává s rozpichem jehel 6,4 mm. Celková rozteč mezi krajními jehlami je tedy 51,2 mm. Doporučeným vybavením je FR406, které umožňuje našít až 4 pásky. Použitím jiných vybavení lze stroj použít i na další šicí operace.

### POUŽITÍ:

- Kalhoty, pracovní oblečení, bundy atd.

### VOLITELNÉ PŘÍSLUŠENSTVÍ:

- PMD – mechanické dávkování
- FR406 – vybavení pro našívání pásek

### GENERAL FEATURES:









This series is supplied with rear puller and standardly supplied with 6,4 mm gauge set. Total needle distance between outer needles is 51,2 mm. Suggested device is FR406 that enables to attach up to 4 tapes. Machine can be used for other sewing operations by using other devices.

### APPLICATION:

- Suitable for various applications, such as trunks, sports pants.

### OPTIONAL DEVICE:

- PMD – Lower feed metering device
- FR406 – Line stripes attaching device

			 (mm)	 (mm)	 (mm)	 UO x 113	 S.P.M.	AVAILABLE DEVICE
MN-4509P-064	9	18	A = 51,2 B = 6,4	1,6–3,6	8	75–90	4500	PMD, FR406

## MN-4512P



DVANÁCTIJEHLOVÉ DVACETIČTYŘNITNÉ STROJE

12-NEEDLE, 24-THREAD MACHINE



### CHARAKTERISTIKA:

Tato řada strojů je standardně dodávána s odtahovým válcem. Lze ji dodat se třemi druhy rozpichů.

Maximální celková rozteč mezi krajními jehlami je tedy:

- 52,8 mm při rozteči 4,8 mm
- 55,0 mm při rozteči jehel 5,0 mm
- 70,4 mm při rozteči jehel 6,4 mm.

### POUŽITÍ:

- Spodní prádlo, košile, kalhoty, pracovní oblečení, povlečení, závěsy, záclony atd.

### VOLITELNÉ PŘÍSLUŠENSTVÍ:

- PMD – mechanické dávkování
- FR406 – vybavení pro našívání pásků
- PS001 – vybavení pro šití pružnou nití (gumičkou)řasení
- PT001 – vybavení „tuxedo“ (šití sklady)

### GENERAL FEATURES:

This series is supplied with rear puller and standardly supplied with three different gauge sets. Total needle distance between outer needles is as follows:

- 52,8 mm (4,8 mm needle distance)
- 55,0 mm (5,0 mm needle distance)
- 70,4 mm (6,4 mm needle distance)

### APPLICATION:

- Suitable for various applications, such as trunks, sports pants.

### OPTIONAL DEVICE:

- PMD – Lower feed metering device
- FR406 – Line stripes attaching device
- PS001 – Elastic thread shirring
- PT001 – Pin tucking

								AVAILABLE DEVICE
MN-4512P-048			A = 52,8 B = 4,8					PMD
MN-4512P-050	12	24	A = 55,0 B = 5,0	1,6–3,6	8	75–90	4500	FR406 PT001
MN-4512P-064			A = 70,4 B = 6,4					PS001



## MN-4513P



**TŘINÁCTIJEHLOVÉ DVACETIŠESTINITNÉ STROJE**

**13-NEEDLE, 26-THREAD MACHINE**

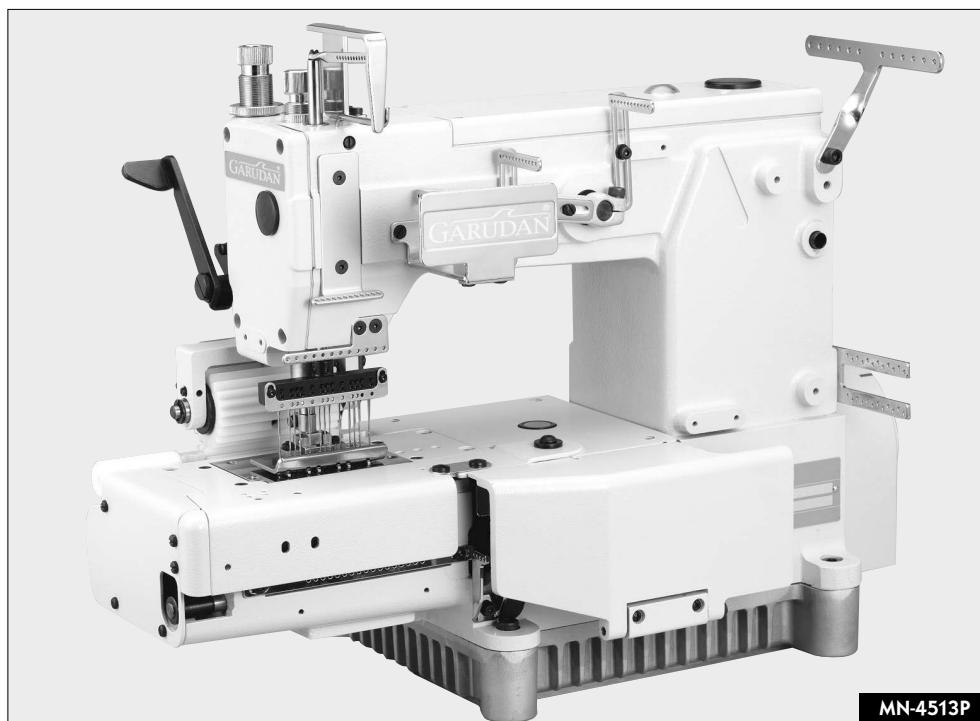

MN-4513P

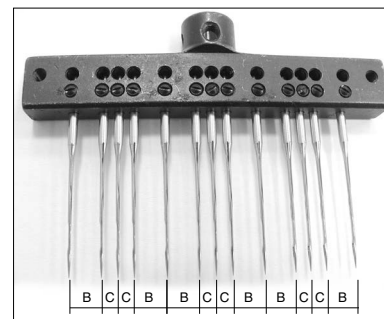
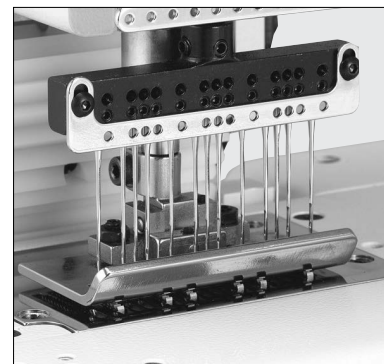

### CHARAKTERISTIKA:

Tento multifunkční stroj se standardně dodává s jehelníkem s rozpichem 6,4 mm. Může být vybaven speciálním jehelníkem (viz foto), který umožňuje multifunkční šití bez nutnosti výměny šicí sady. Stroj je standardně dodáván s odtahovým válcem.

Maximální celková rozteč mezi krajními jehlami je 76,8 mm nebo 57,6 mm.

### POUŽITÍ:

- Spodní prádlo, košile, kalhoty, pracovní oblečení, povlečení, závěsy, záclony atd.

### VOLITELNÉ PŘÍSLUŠENSTVÍ:

- PMD – mechanické dávkování
- FR406 – vybavení pro našívání pásků

### GENERAL FEATURES:

This multi-function machine can be equipped with special needle clamp that enables to sew with three different maximum needle distances without changing needle gauges. This series is supplied with rear puller.









Total needle distance between outer needles is 76,8 mm or 57,6 mm.

### APPLICATION:

- Suitable for various applications, such as trunks, sports pants.

### OPTIONAL DEVICE:

- PMD – Lower feed metering device
- FR406 – Line stripes attaching device

			 (mm)	 (mm)	 (mm)	 UO x 113	 S.P.M.	AVAILABLE DEVICE
MN-4513P-064 MN-4513P-064-032	13	26	A = 76,8 B = 6,4 A = 57,6 B = 6,4 C = 3,2	1,6–3,6	8	75–90	4500	PMD FR406

MN PMD

MECHANICKÉ SPODNÍ DÁVKOVÁNÍ GUMIČKY

ELASTIC TAPE INSERTING ATTACHING

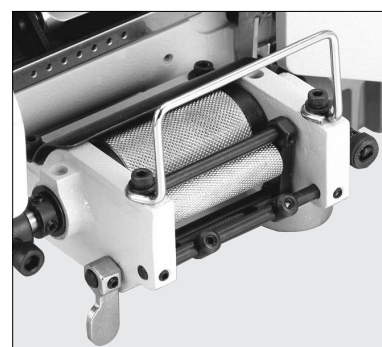
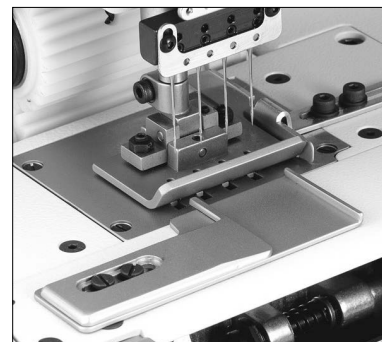
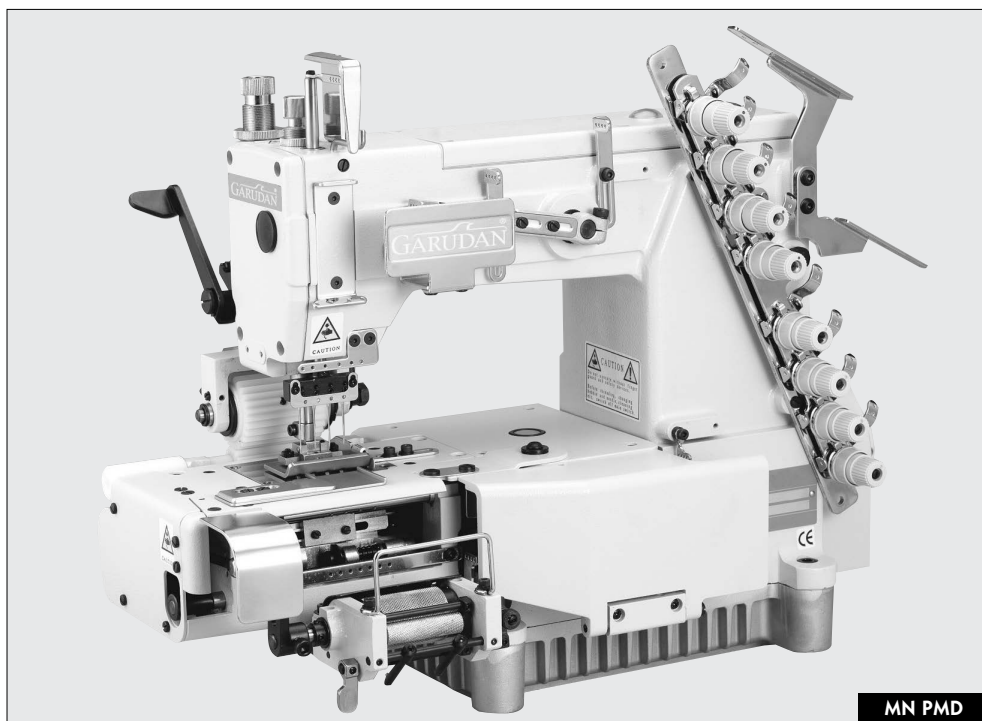

#### CHARAKTERISTIKA:

Tato řada strojů je standardně dodávána s odtahovým válcem a mechanickým dávkováním gumičky. Dopručeným vybavením je FR405 nebo SF. Použitím jiných vybavení lze stroj použít i na další šicí operace.

#### POUŽITÍ:

- Všívání gumy do pasového límce. Kalhoty, pracovní oblečení, bundy atd.







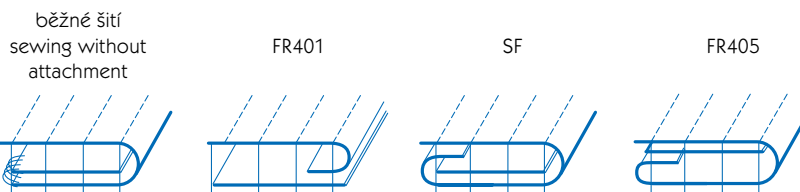

#### GENERAL FEATURES:

This series is supplied with rear puller and elastic tape inserting attaching. Suggested device is FR405 or SF. Machine can be used for other sewing operations by using other devices.

#### APPLICATION:

- Suitable for attaching elastic waistband to trunks or boxers, sports pants etc.



			 (mm)	 (mm)	 (mm)	 UO x 113	 S.P.M.	AVAILABLE DEVICE
MN-4504P-xxx/PMD	4	8	Mohou být použity	1,6–3,6	8	75–90	4000	FR401 FR405 SF
MN-4506P-xxx/PMD	6	12	všechny standardní					
MN-4509P-xxx/PMD	9	18	rozpichy.					
MN-4512P-xxx/PMD	12	24	All standard needle					
MN-4513P-xxx/PMD	13	26	gauges can be used.					

## MN PS001

ŠITÍ PRUŽNOU NITÍ (GUMIČKOU) – ŘASENÍ

ELASTIC THREAD SHIRRING

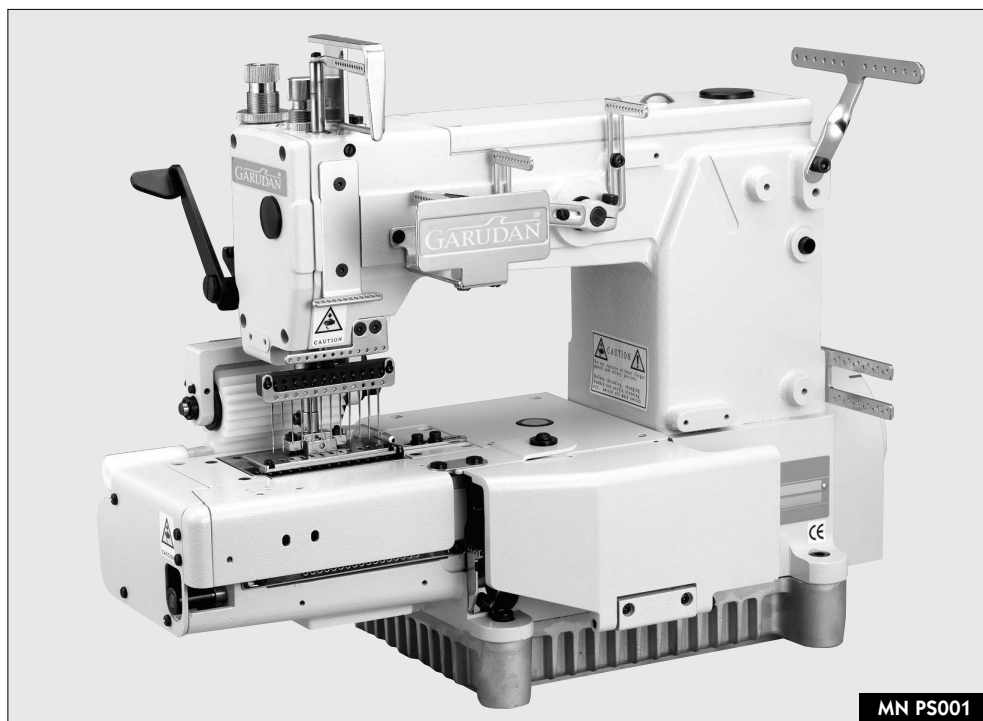

MN PS001



### CHARAKTERISTIKA:

Tato řada strojů se dodává pouze ve 12-ti jehlovém provedení. Stroj je standardně vybaven hladkým polyurethanovým odtahovým válcem. Místo spodních nití se používá nit pružná, která výrobek „stáhne“, šev zůstává pružný.

### POUŽITÍ:

- Ozdobné pružné našasení







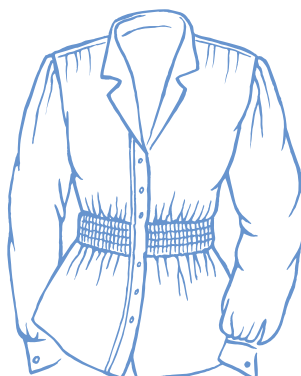

### GENERAL FEATURES:

This series is supplied with 12-needle version with 0-teeth polyurethan rear puller. Machines use elastic threads instead of standard bottom threads. This enables to achieve elastic seam.

### POUŽITÍ:

- Suitable for ladies fashion wear.



			 (mm)	 (mm)	 (mm)	 UO x 113	 S.P.M.	AVAILABLE DEVICE
MN-4512P0-048/PS001 MN-4512P0-064/PS001	12	24	A = 52,8    B = 4,8 A = 70,4    B = 6,4	1,6–3,6	8	75–90	4000	

## MN PT001

ŠITÍ SKLADŮ  
PIN TUCKING

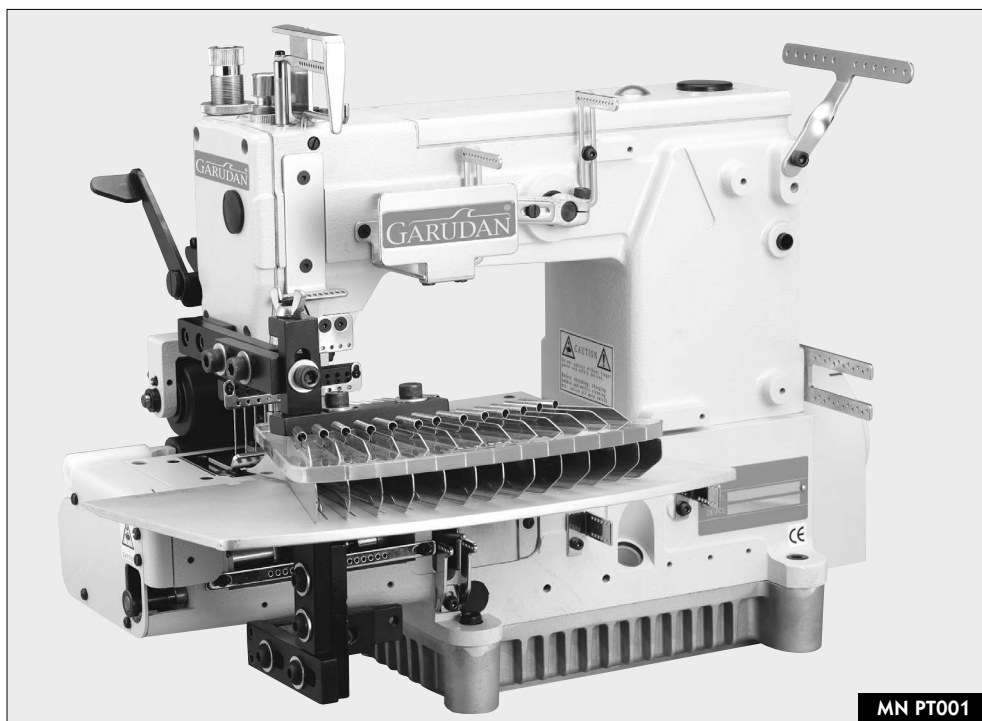

MN PT001

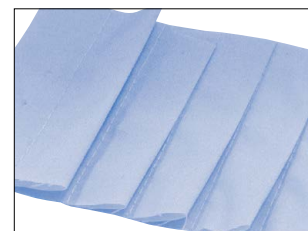

### CHARAKTERISTIKA:

Tato řada strojů se dodává pouze ve 12-ti jehlovém provedení. Stroj je standardně vybaven hladkým polyurethanovým odtahovým válcem. Speciální aparát vytvoří záhyby, které jsou následovně zašity.

### POUŽITÍ:

- Tzv. „tuxedo“ ozdobné šití na pánských košilích, nebo dámských halenkách.









### GENERAL FEATURES:

This series is supplied with 12-needle version with 0-teeth polyurethan rear puller. Special device makes bends that are subsequently seamed.

### APPLICATION:

- Suitable for men's tuxedo shirts etc.



			 (mm)	 (mm)	 (mm)	 UO x 113	 S.P.M.	AVAILABLE DEVICE
MN-4512P0-048/PT001 MN-4512P0-064/PT001	12	24	A = 52,8 B = 4,8 A = 70,4 B = 6,4	1,6–3,6	8	75–90	2500	

## MN FR406



NAŠÍVÁNÍ OZDOBNÝCH PÁSKŮ

LINE STRIPES ATTACHING

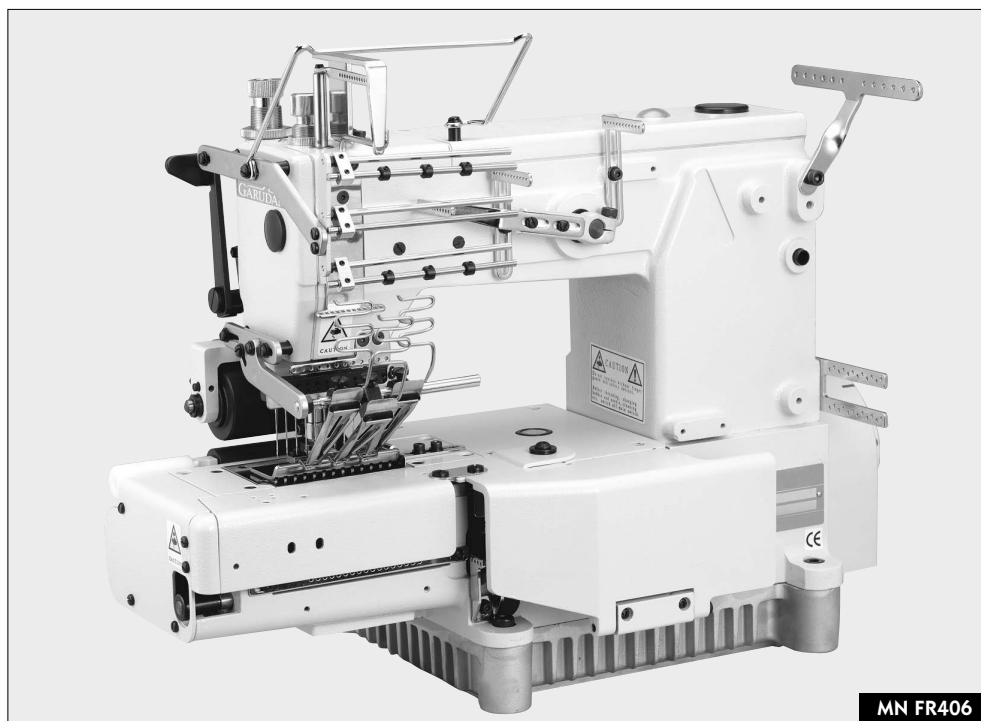

MN FR406



### CHARAKTERISTIKA:

Tato řada strojů se dodává pouze ve 12-ti jehlovém provedení. Stroj je standardně vybaven hladkým polyurethanovým odtahovým válcem.

### POUŽITÍ:

- Sportovní kalhoty, bundy apod.







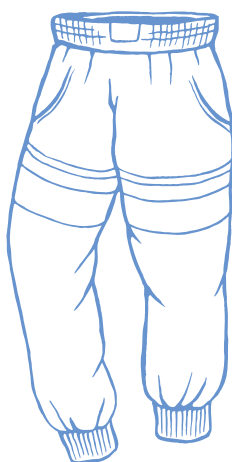

### GENERAL FEATURES:

This series is supplied with 12-needle version with 0-teeth polyurethan rear puller.

### APPLICATION:

- Suitable for various applications, such as trunks, sports pants.



			 (mm)	 (mm)	 (mm)	 UO x 113	 S.P.M.	AVAILABLE DEVICE
MN-4512P0-048/FR406 MN-4512P0-064/FR406	12	24	A = 52,8    B = 4,8 A = 70,4    B = 6,4	1,6-3,6	8	75-90	4000	

VOLITELNÉ PŘÍSLUŠENSTVÍ  
**PMD**  
OPTIONAL DEVICE

**MECHANICKÉ DÁVKOVÁNÍ GUMY**  
**LOWER FEED METERING DEVICE**

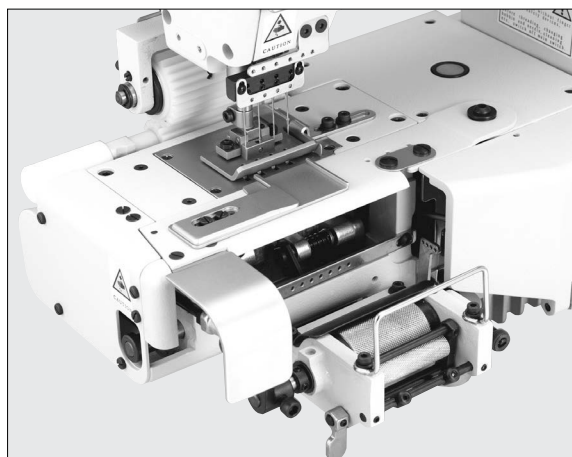

- Zajišťuje přesné dávkování gumy při jejím všívání do pasového límce.
- Lower feed metering device.



Možnosti všívání gumy:  
Application:



VOLITELNÉ PŘÍSLUŠENSTVÍ  
**FR401**  
OPTIONAL DEVICE

**ZAKLADAČ PRO ŠITÍ GUMY DO PASU (OTEVŘENÉ PŘÍKRYTÍ)**  
**ELASTIC HEMMING – 2 FOLDS**

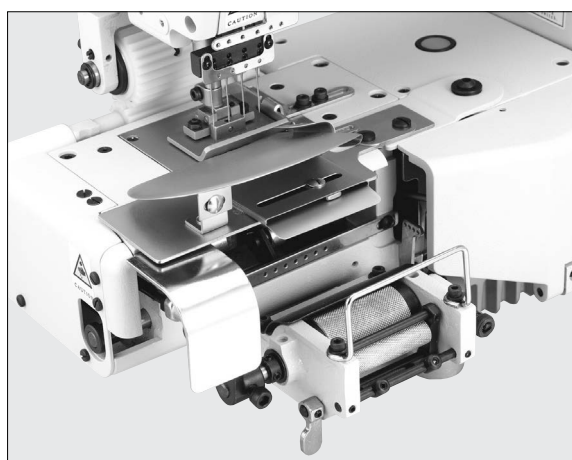

- Zajišťuje podehnutí materiálu a jeho našití na pod ním vedenou gumičku. (Max. šíře gumy je 40 mm)
- Elastic hemming – 2 folds.

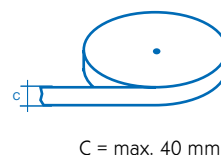
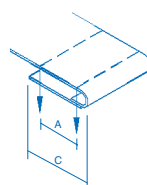

VOLITELNÉ PŘÍSLUŠENSTVÍ  
**FR402**  
OPTIONAL DEVICE

**ZAKLADAČ PRO ŠITÍ PASOVÉHO LÍMCE (PŘÍMÉ ŠITÍ)**  
**TOP AND BOTTOM WAISTBAND ATTACHMENT**

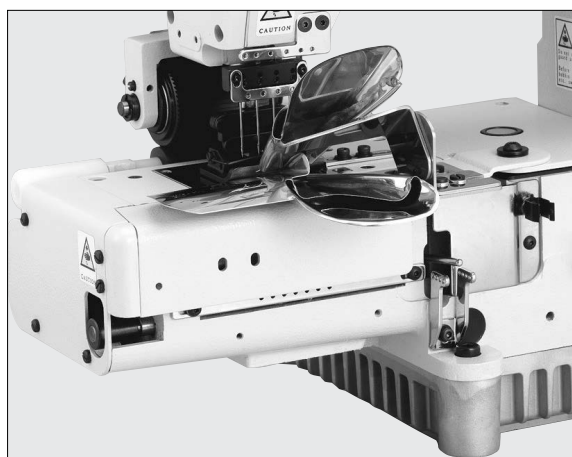

- Zajišťuje založení 2 pásků např. při šití předního dílu košil, prac. oblečení atd.
- Top and bottom waistband attachment.

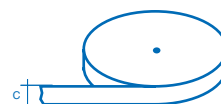
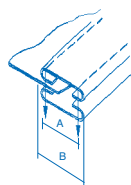

A (mm)	B (mm)	C (mm)
38,1	42	65
31,8	35	56

VOLITELNÉ PŘÍSLUŠENSTVÍ  
**FR403**  
OPTIONAL DEVICE

**ZAKLADAČ PRO ŠITÍ PASOVÉHO LÍMCE (TVAROVÉ ŠITÍ)**

**TOP AND BOTTOM WAISTBAND ATTACHING**



- Zajišťuje založení 2 pásků, případně šití pásku límce (tvarové šití).
- Top and bottom waistband attaching.

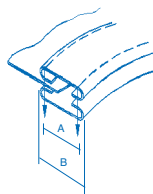

A (mm)	B (mm)	C (mm)
38,1	42	65
31,8	35	56

VOLITELNÉ PŘÍSLUŠENSTVÍ  
**FR404**  
OPTIONAL DEVICE

**LEMOVAČ PRO ŠITÍ PASOVÉHO LÍMCE**

**CURVE WAISTBAND ATTACHING**

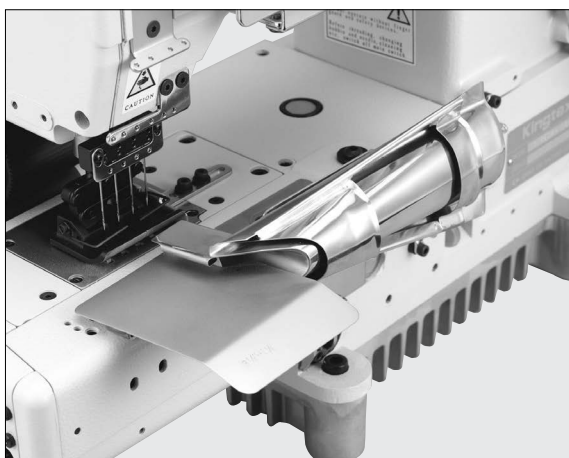

- Zajišťuje založení pásového límce.
- Curve waistband attaching.

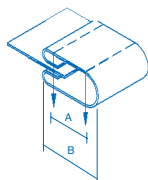

A (mm)	B (mm)	C (mm)
38,1	42	110
31,8	35	95
25,4	30	85

VOLITELNÉ PŘÍSLUŠENSTVÍ  
**FR405**  
OPTIONAL DEVICE

**ZAKLADAČ PRO ŠITÍ GUMY DO PASU (UZAVŘENÉ PŘÍKRYTÍ)**

**ELASTIC HEMMING – 3 FOLDS**



- Zajišťuje založení materiálu a uložení gumy do vytvořeného tunýlku.
- Elastic hemming – 3 folds.

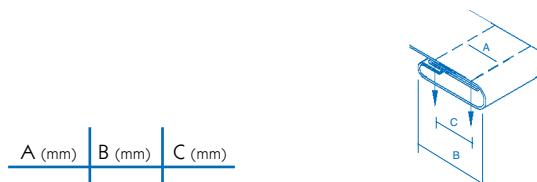

A (mm)	B (mm)	C (mm)
28,5	33	31
25,4	30	28
38,1	42	40
19,1	25	23
31,8	35	34

VOLITELNÉ PRÍSLUŠENSTVÍ  
**FR406**  
OPTIONAL DEVICE

**NAŠÍVÁNÍ OZDOBNÉ PÁSKY**  
**LINE STRIPES ATTACHING**



- Zajišťuje založení ozdobných pásků.
- Line stripes attaching.

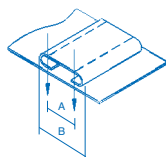

A (mm)	B (mm)	C (mm)
4,8	8	16
6,4	9,5	19

VOLITELNÉ PRÍSLUŠENSTVÍ  
**SF**  
OPTIONAL DEVICE

**SPIRÁLOVÝ ZAKLADAČ**  
**SPIRAL FOLDER**

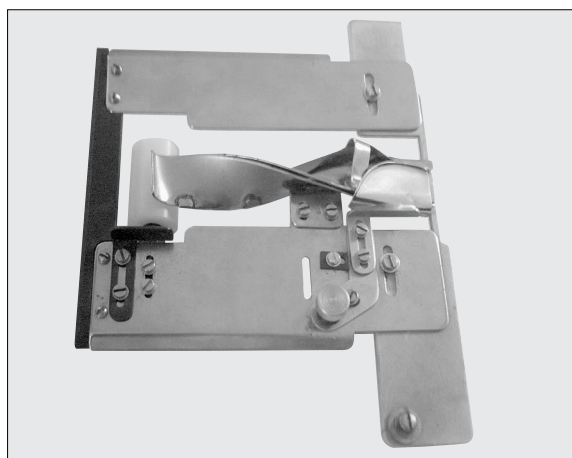

- Komfortní šití pásového límce, kdy je guma obalena materiálem.
- Comfortable waistband sewing, elastic tape is covered by material.

A (mm)	B (mm)	C (mm)
28,5	33	31
25,4	30	28
38,1	42	40
19,1	25	23
31,8	35	34

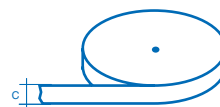
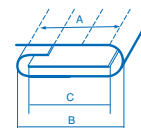



A series of horizontal dotted lines for writing, organized into two columns.

A series of horizontal dotted lines for writing, organized into two columns.



Typ Model

# MN-4500 series

Vícejehlové ramenové stroje

Multi needle machines

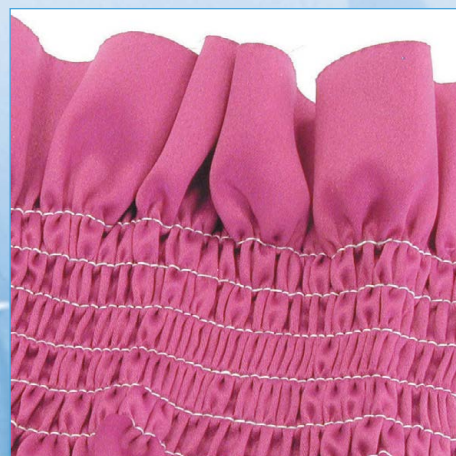
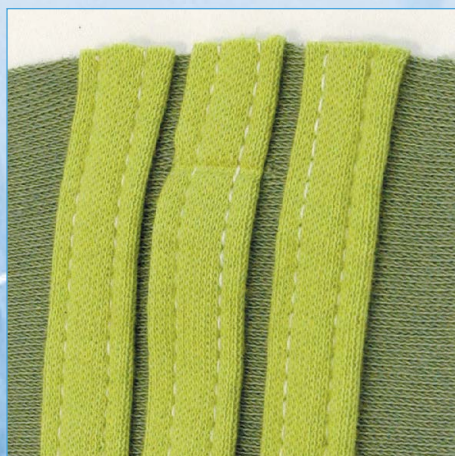
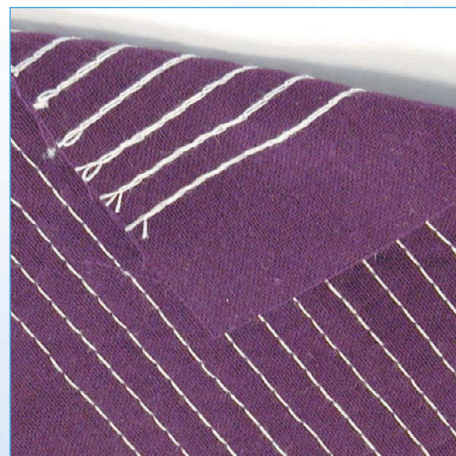

ANITA B s.r.o.  
Hliníky 2068  
680 01 Boskovice  
Czech Republic  
tel.: +420 516 454 774, 516 453 496  
fax: +420 516 452 751  
e-mail: info@anita.cz  
www.garudan.cz

Změna vzhledu a parametrů vyhrazena. Changes in outer appearance and in parameters are reserved.

LF00034 CZ/EN 02/2018